

ER5A THRU ER5J

VOLTAGE RANGE 50 to 600 Volts
CURRENT 5.0 Ampere

FEATURES

- Plastic package has underwrites laboratory flammability Classification 94V-0
- For surface mounted applications
- Low profile package
- Built-in strain relief, ideal for automated placement
- Glass Passivated chip junction
- High temperature soldering: 250°C/10 second at terminals

MECHANICAL DATA

- Case: JEDED DO-214AB transfer molded plastic
- Terminals: Solder plated, Solderable per MIL-STD-750, method 2026
- Polarity: Color band denotes cathode end
- Weight: 0.007ounce, 0.25 gram

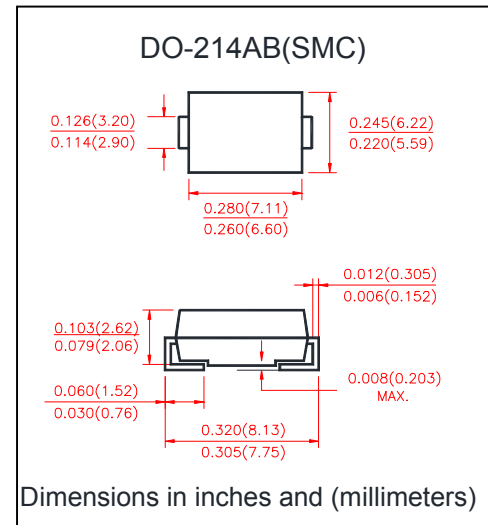

MAXIMUM RATINGS AND ELECTRICAL CHARACTERISTICS

- Ratings at 25°C ambient temperature unless otherwise specified.
- Single phase, half wave, 60Hz, resistive or inductive load.
- For capacitive load derate current by 20%.

	SYMBOLS	ER5A	ER5B	ER5C	ER5D	ER5E	ER5G	ER5J	UNIT
Maximum Repetitive Peak Reverse Voltage	V_{RRM}	50	100	150	200	300	400	600	Volts
Maximum RMS Voltage	V_{RMS}	35	70	105	140	210	280	420	Volts
Maximum DC Blocking Voltage	V_{DC}	50	100	150	200	300	400	600	Volts
Maximum Average Forward Rectified Current at $T_J=100^\circ\text{C}$	$I_{(AV)}$	5.0							Amps
Peak Forward Surge Current 8.3ms single half sine-wave superimposed on rated load (JEDEC method)	I_{FSM}	150							Amps
Maximum Instantaneous Forward Voltage @ 5.0A	V_F	0.95			1.25		1.7		Volts
Maximum DC Reverse Current at rated DC Blocking Voltage per element	I_R	$T_A = 25^\circ\text{C}$							μA
		$T_A = 125^\circ\text{C}$							
Typical Reverse Recovery Time Test conditions $I_F=0.5\text{A}$, $I_R=1.0\text{A}$, $I_{RR}=0.25\text{A}$	t_{rr}	35							nS
Typical Junction Capacitance (Measured at 1.0MHz and applied reverse voltage of 4.0V)	C_J	45				30			pF
Typical Thermal Resistance (Note 1)	$R_{\theta JA}$	47							$^\circ\text{C}/\text{W}$
	$R_{\theta JL}$	13							
Operating Junction Temperature Range	T_J	(-55 to +150)							$^\circ\text{C}$
Storage Temperature Range	T_{STG}	(-55 to +150)							$^\circ\text{C}$

Notes:

1. Thermal resistance from Junction to ambient and from junction to lead mounted on P.C.B. with 0.3×0.3" (8.0 × 8.0mm) copper pad areas.



WEET Technology Company Limited

Ultra-Fast Recovery Rectifiers

ER5A THRU ER5J

VOLTAGE RANGE 50 to 600 Volts
CURRENT 5.0 Ampere

RATING AND CHARACTERISTIC CURVES

FIG.1-TYPICAL FORWARD CURRENT DERATING CURVE

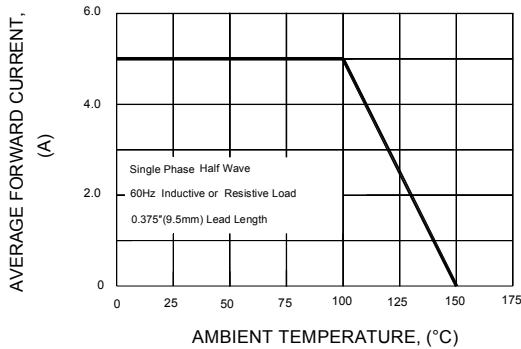

FIG.2-MAXIMUM NON-REPETITIVE PEAK FORWARD SURGE CURRENT

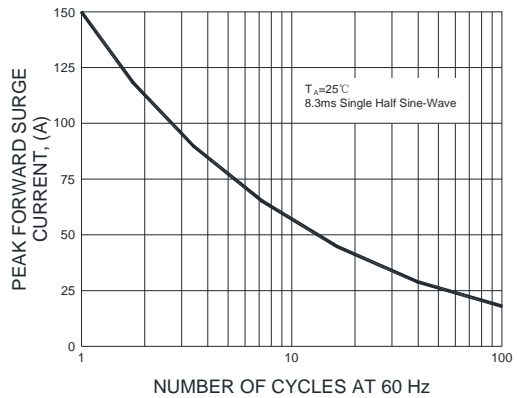

FIG.3-TYPICAL INSTANTANEOUS FORWARD CHARACTERISTICS

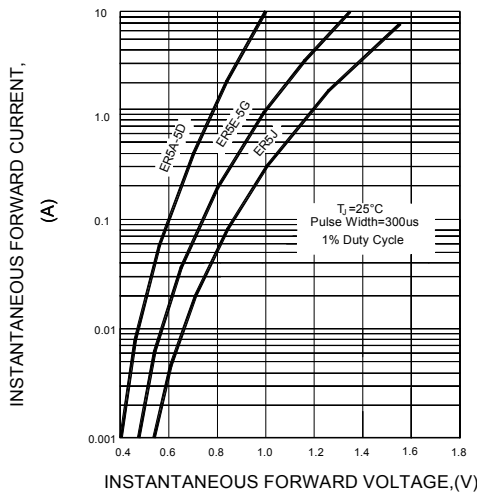

FIG.4-TYPICAL REVERSE CHARACTERISTICS

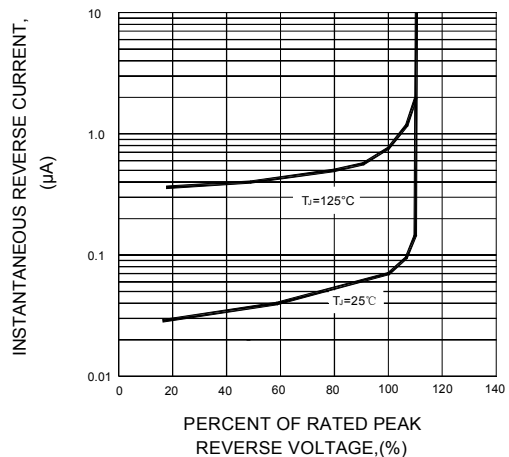

FIG.5-TYPICAL JUNCTION CAPACITANCE

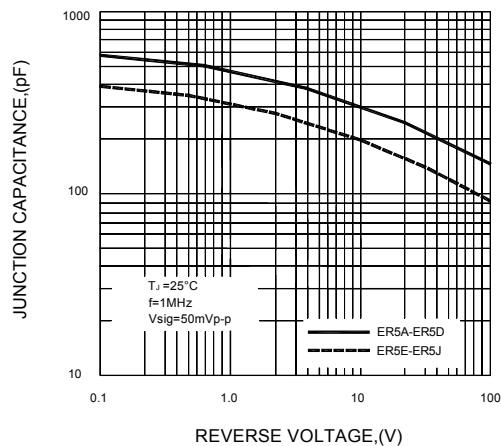
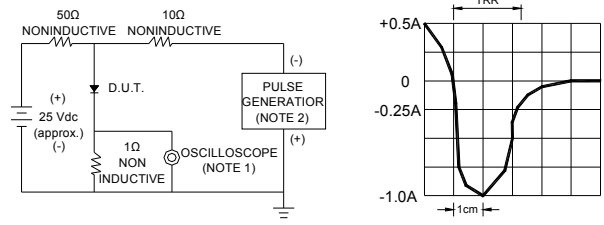

FIG.6-TEST CIRCUIT DIAGRAM AND REVERSE RECOVERY TIME CHARACTERISTIC



NOTES : 1.Rise Time=7ns max. Input Impedance= 1 megohm. 22pF
2.Rise time=10ns max. Source Impedance= 50 ohms

SET TIME BASE FOR 50/100ns/cm

Note: Specifications are subject to change without notice. For more detail and update, please visit our website.